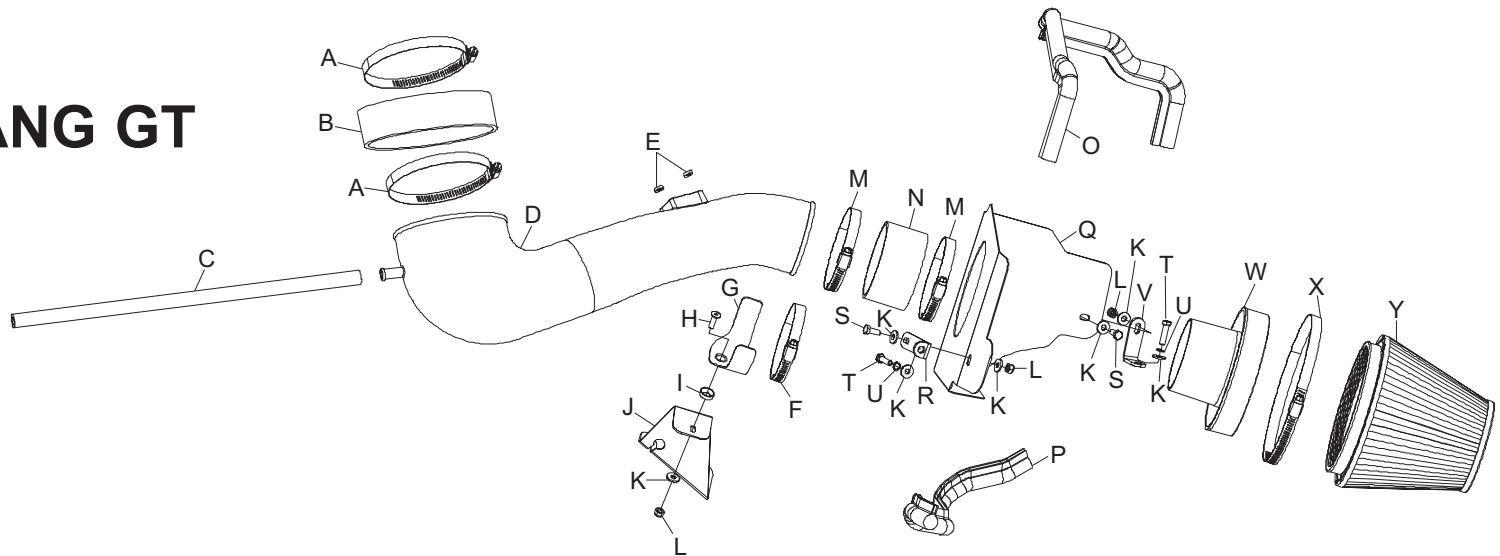

INSTALLATION INSTRUCTIONS
57-2565
FORD
2005 MUSTANG GT
V8-4.6L
TOOLS NEEDED:

 Flat Blade Screwdriver
 Ratchet
 Extension
 8mm socket
 10mm socket
 10mm wrench
 4mm Allen
 Needle nose pliers

PARTS LIST

Desc.	Qty.	Part #	Desc.	Qty.	Part #	Desc.	Qty.	Part #
A hose clamp #72	2	08671	H bolt; 6mm-1.00 x 20mm, f/h/a	1	08376	O edge trim 30"	1	102489
B hose; 2" id x 6.13" id oval,	1	08541	I cup washer, black nylon	1	08180	P edge trim 23"	1	102495
C hose; 3/8" id x 17" l	1	08404	J bracket	1	010098	Q heat shield	1	074038
D intake tube (EW)	1	087166	K washer; 1/4" id x 5/8" od flat	7	08275	R bracket; "L"	1	07158
E spacer; .437" od x .200 x .115" thk	2	06503	L nut; 6mm nylock	3	07553	S bolt; 6mm-1.00 x 16mm, hex	2	07703
F hose clamp #52	1	08610	M hose clamp #56	2	08620	T bolt; 6mm-1.00 x 25mm, hex	2	07704
G saddle bracket	1	078855	N hose; 3.5" id x 2" l, black silicone	1	08698	U washer; 1/4" split lock	2	08198
						V bracket "L"	1	070812
						W adapter #452	1	21518
						X hose clamp #104	1	08697
						Y filter charger	1	RF-1048

TO START:

1. Turn the ignition OFF and disconnect the vehicle's negative battery cable.



2. Release the red locking tab and then disconnect the mass air sensor electrical connection.



3. Rotate the green locking tab clockwise and then disconnect the crank case breather hose from the valve cover as shown.



4. Loosen the hose clamps, which secure the intake tube to the throttle body and air box, then remove the intake tube as shown.

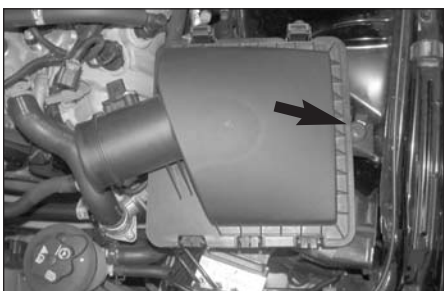

5. Remove the air box mounting bolt shown.



6. Remove the air box assembly as shown.



7. Install the saddle clamp onto the tube-mounting bracket as shown with the provided hardware.

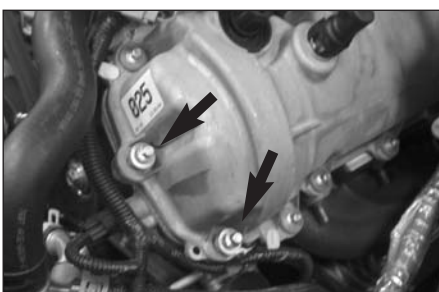

8. Remove the two valve cover bolts shown.
NOTE: These bolts will be reused.



9. Install the valve cover bolts removed in step #8 into the tube mounting bracket as shown passing through the key hole portion and then slide the bolts to the end of the slots.



10. Install the tube-mounting bracket onto the valve cover as shown and secure with the stock hardware removed in step #8.

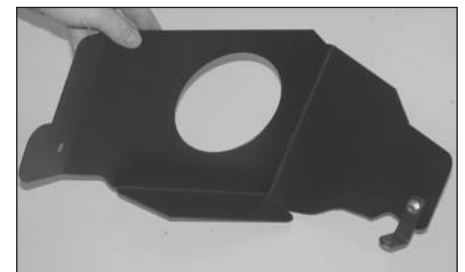

11. Install the "L" bracket (070812) onto the rear of the heat shield as shown with the provided hardware.



12. Install the "L" bracket (07158) onto the front of the heat shield as shown with the provided hardware.



13. Install the edge trim onto the heat shield as shown.
NOTE: Some trimming of the edge trim may be necessary for proper fit.

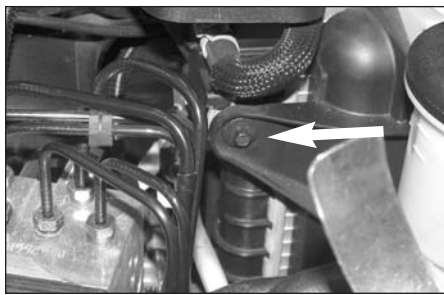

14. Remove the radiator fan shroud mounting bolt shown.
NOTE: This bolt will not be reused.



15. Install the heat shield and secure with the provided hardware as shown.
NOTE: The forward mounting bracket will mount to the radiator fan shroud mounting location and the rear bracket will mount to the air box mounting location.



16. Remove the mass air sensor from the factory air box with the T20 "TORX" wrench provided.

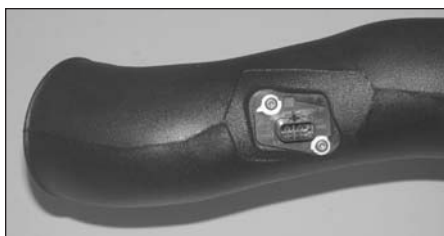

17. Install the mass air sensor into the K&N intake tube with the factory mounting screws and two spacers provided.



18. Install the silicone hose (08541) onto the throttle body with the provided hose clamps as shown.



19. Install the K&N intake tube into the silicone hose at the throttle body and onto the saddle bracket assembly then secure with the provided hose clamps as shown.



20. Install the supplied vent hose onto the vent port on the valve cover and then onto the K&N intake tube as shown.

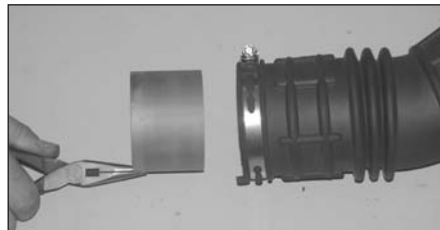

21. Vehicles that come equipped with Hydrocarbon trap, use a pair of needle nose pliers, to remove the Hydrocarbon trap from the stock intake tube as shown.
NOTE: The Hydrocarbon trap coating is very fragile; care should be taken during removal as not to damage it.

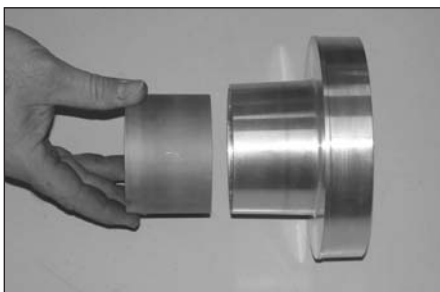

22. Vehicles that come equipped with Hydrocarbon trap, place the Hydrocarbon trap into the filter adapter as shown.
NOTE: This intake system is designed to use the factory Hydrocarbon trap, Failure to use the Hydrocarbon trap will result in poor performance and possible engine damage may result.



23. Install the silicone hose (08698) onto the filter adapter and secure with the provided hose clamp as shown.



24. Install the FILTERCHARGER onto the filter adapter and secure with the provided hose clamp as shown.



25. Install the FILTERCHARGER assembly onto the K&N intake tube as shown and secure with the provided hose clamp.



26. Reconnect the mass air sensor electrical connection as shown.



27. Reconnect the vehicle's negative battery cable. Double check to make sure everything is tight and properly positioned before starting the vehicle.

28. The C.A.R.B. exemption sticker, (attached), must be visible under the hood so that an emissions inspector can see it when the vehicle is required to be tested for emissions. California requires testing every two years, other states may vary.

29. It will be necessary for all FIPK's to be checked periodically for realignment, clearance and tightening of all connections. Failure to follow the above instructions or proper maintenance may void warranty.

ROAD TESTING:

1. Start the engine with the transmission in neutral or park, and the parking brake engaged. Listen for air leaks or odd noises. For air leaks secure hoses and connections. For odd noises, find cause and repair before proceeding. This kit will function identically to the factory system except for being louder and much more responsive.
2. Test drive the vehicle. Listen for odd noises or rattles and fix as necessary.
3. If road test is fine, you can now enjoy the added power and performance from your kit.
4. K&N suggests checking the Filtercharger element periodically for excessive dirt build-up. When the element becomes covered in dirt (or once a year), service it according to the instructions on the Recharger service kit, part number 99-5050 or 99-5000.